

libbi

HOME BATTERY



Model No.

LIBBI-305Sh, LIBBI-310Sh, LIBBI-315Sh, LIBBI-320Sh,
LIBBI-505Sh, LIBBI-510Sh, LIBBI-515Sh, LIBBI-520Sh

User Operating Instructions

Copyright

Copyright of these instructions remains with the manufacturer. Text and images correspond to the technical level at the time of going to press. We reserve the right to make changes. The content of the operating instructions shall not give rise to any claims on the part of the purchaser. We are grateful for any suggestions for improvement and notices of errors in the operating instructions, myenergi libbi, myenergi zappi, myenergi eddi, myenergi harvi and myenergi hub are registered trademarks of myenergi ltd.

Liability Limitation

myenergi do not accept any direct or indirect liability for product damage or property loss caused by the following conditions:

- Product modified, design changed or parts replaced without authorisation
- Changes, repair attempts and erasing of serial numbers or seals by an unauthorised person
- System design and installation were not in compliance with standards and regulations; failure to comply with the local safety regulations
- Transport damage (including scratches to enclosure caused by rubbing of packing during shipping)
- Failure to follow any and/or all user manuals, installation guides and maintenance regulations
- Improper use or misuse of the device
- Force majeure (stormy weather, lightning overvoltage, fire etc.)
- Damage from external factors

Contents

1. Introduction.....	4	8. Firmware Updates.....	11
1.1 Safety	4	9. Operation After Power Failure	11
2. Product Description.....	5	10. Fault Codes.....	11
2.1 Product Introduction	5	11. Routine Maintenance & Cleaning	13
3. Product Registration.....	5	11.1 Emergency Power Down Procedure	13
3.1 First Time User? Register for an Account.....	5	11.2 Battery Reboot	13
3.2 Existing Users.....	5	12. Warranty	14
4. myenergi app.....	5	13. Installer Portal	14
4.1 Choose green or grid	5	14. Technical Support.....	14
4.2 Input Electricity Tariff.....	6	15. Our Products	14
4.3 Setting Priorities	6		
5. libbi and zappi	8		
6. libbi and eddi	8		
7. System Appearance.....	9		
7.1 Battery and Inverter	9		
7.2 Controller	10		
7.3 Controller Status Screens	10		

1. Introduction

1.1 Safety

Read all the safety instructions. Failure to operate the libbi in accordance with these instructions may cause injury or death, damage to the unit or inefficient operation and invalidate the manufacturer's warranty.

The libbi utilises warning signs which contain important information for the system to be operated safely. Ensure these remain undamaged and clear to read. If damaged, warning signs must be replaced immediately.

Manual Keeping

This manual contains important information about operating the system. Before operating, please read it very carefully. The system should be operated in strict accordance with the instructions in this manual. This manual should be kept for future maintenance and reparation for the duration of the products lifecycle.



Indicates a hazardous situation which, if not avoided, could result in death or serious injury.



Indicates a notice or 'tip' to guide you.

DANGER

Danger to life due to high voltages of the PV array, battery and electric shock. When exposed to sunlight, the PV array generates a dangerous DC voltage which will be present in the DC conductors and the live components of the inverter. Touching the DC conductors or the live components can lead to lethal electric shocks. If you disconnect the DC connectors from the system under load, an electric arc may occur leading to electric shock and burns. Therefore, for safety reasons, safe isolation must be carried out with a properly calibrated voltage tester before an installer works on the equipment.

- The inverter can keep a life-threatening voltage even after disconnecting it from the DC and/or AC side
- Do not touch uninsulated cable ends
- Do not touch the DC conductors
- Do not open the inverter and battery
- Do not wipe the system with a wet cloth
- Have the system installed and commissioned by qualified personnel with the appropriate skills only

Prior to performing any work on the inverter or the battery pack, disconnect the inverter from all voltage sources, as described in this document.

The emergency power down procedure can be found in this document on **page 13**.

WARNING

Risk of chemical burns from electrolyte or toxic gases. During normal operation, no electrolyte shall leak from the battery pack and no toxic gases shall form. Despite careful construction, if the battery pack is damaged or a fault occurs, it is possible that electrolyte may be leaked or toxic gases formed.

- Do not touch the system with wet hands
- Do not put any heavy objects on top of the system

- Do not damage the system with sharp objects
- Do not operate the system in potentially explosive atmospheres or areas of high humidity
- If moisture has penetrated the system (e.g. due to a damaged enclosure), do not operate the system
- The libbi is not to be used by persons (including children) with reduced physical, sensory, or mental capabilities, or lack of experience and knowledge, unless they are supervised or have been given instruction concerning use of the device by a person responsible for their safety
- The transportation of libbi system must be arranged by the manufacturer or instructed personnel, including the Installer. These instructions shall be recorded and repeated
- In case of contact with electrolyte, rinse the affected areas immediately with water and consult a doctor without delay
- Avoid any maintenance to this equipment in adverse weather conditions, when located outdoors

Battery Safety Information

This product is a Lithium Iron Phosphate Battery with certified compliance under the UN Recommendations on Transport of Dangerous Goods, Manual of Tests and Criteria, Part III, subsection 38.3. For battery cell, chemical materials are stored in a hermetically sealed metal case, designed to withstand temperatures and pressures encountered during normal use. As a result, during normal use, there is no physical danger of ignition or explosion and chemical danger of hazardous materials' leakage. However, if the product is exposed to fire, mechanical shocks or electric stress by misuse, the gas release vent will be opened. The battery cell case will be breached at the extreme. Hazardous materials may be released. Moreover, if heated strongly by the surrounding fire, acid or harmful fumes may be emitted.

Product Information Sheet

For detailed information please refer to the Product Information Sheet which can be found on the myenergi website.

www.myenergi.com/installers-centre/download-centre/

Disposal

In accordance with European Directive 2012/19/EU on waste electrical and electronic equipment and its implementation in national law, used electrical devices must be collected separately and recycled in an environmentally responsible manner. Ensure that you return your used device to myenergi or obtain information regarding a local, authorised collection and disposal system. Failure to comply with this EU Directive may result in a negative impact on the environment.

Operation after power failure

The battery system is part of the energy storage system which stores life-threatening high voltage current (even when the DC side is turned off). Touching the battery outlets is strictly prohibited. The inverter can keep a life-threatening voltage even after disconnecting it from the DC and /or AC side. Therefore, for safety reasons, it must be tested with a properly calibrated voltage tester before an installer works on the equipment.

2. Product Description

2.1 Product Introduction

Thank you for choosing libbi. These instructions will help you to familiarise yourself with the libbi energy storage system. These instructions will help you familiarise yourself with the product, and ensure you get the maximum benefit from your new eco-smart device.

libbi is an energy storage system that enables surplus energy produced by a PV array, or other renewable generation, to be stored for a home's future use, instead of being exported back out to the grid. It can also be installed in homes where no generation is installed, to maximise the benefits of off-peak Time of Use Tariff prices.

libbi can be installed as a standalone product but will work in conjunction with other myenergi products: zappi, eddi, harvi, for a super 'eco-smart' home.



libbi is NOT compatible with zappi V1

3. Product Registration

3.1 First Time User? Register for an Account

If this is your first myenergi device your installer will talk you through the following simple steps to get your account up and running.

Step 1: Download the myenergi app



Android users can download the myenergi app on Google Play



Apple users can download the myenergi app in the App Store

1. Open the app and click, 'Register for an account'.
2. Enter an email address and create a password, when prompted.
3. Select your contact preferences then click 'next'.
4. Check the email you registered with for a verification code.
5. Enter the code into the app, where requested and press 'next'

Step 2: Set your location and add your first device

1. In the app click the green '+' symbol to add your first location.
2. When asked if you have a 'hub' select, 'No' as this is your first device which already has a built-in virtual hub (vHub).
3. Enter the 'Reg S/N' and 'Reg code' (These can be found in your libbi or vHub enabled device settings; **menu > Information > Page 2.**)
4. Once complete, your device will now display in your myenergi account and app.

Step 3: Customer Details

1. Visit myaccount.myenergi.com from a web browser.
2. Log in with the same credentials used to register for the app.
3. Click on 'My Dashboard'.
4. In the section titled 'Finish setting up your account', click 'Add account details'.

5. Click 'Edit personal info' and complete the form with the required information.
6. Click, 'Submit'.

Congratulations! You're all set. You can now use the myenergi app and myaccount to monitor your energy consumption in real time, wherever you are in the world.

3.2 Existing Users

Already have a myenergi device and registered account?

1. Your installer will pair your new device to your existing system.
2. You will see your new device is automatically added to your myenergi account and app.

4. myenergi app

The myenergi app allows you to control and monitor your myenergi devices, in real-time, from anywhere in the world.



4.1 Choose green or grid

You choose whether you want your libbi to charge using energy generated from your solar or wind generation (Green energy) or a mixture of generation and grid. There is a simple tick box in the myenergi app for you to set this option. You can change this at any time.

4.1.1 Green only charging

To use only the energy generated by your solar or wind generation, click the battery symbol on the home screen of your myenergi app, then untick the box labelled "Enable charging from the grid". When unticked libbi will never pull any energy from the grid.

4.1.2 Green and Grid charging

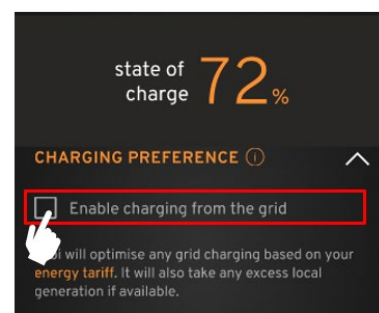

If you would like to utilise a time of use tariff, where prices are typically cheaper overnight, simply click on the battery symbol on the home screen of the myenergi app, then tick the box labelled "Enable charging from the grid" under "Charging Preferences"

libbi will always store your generated energy first before pulling anything from the grid. If you are on a dual rate tariff you will need to enter your tariff details into the myenergi app to enable charging from the grid. This way libbi knows when it

is cheaper for you to use energy and it will only pull from the grid at these cheapest times.

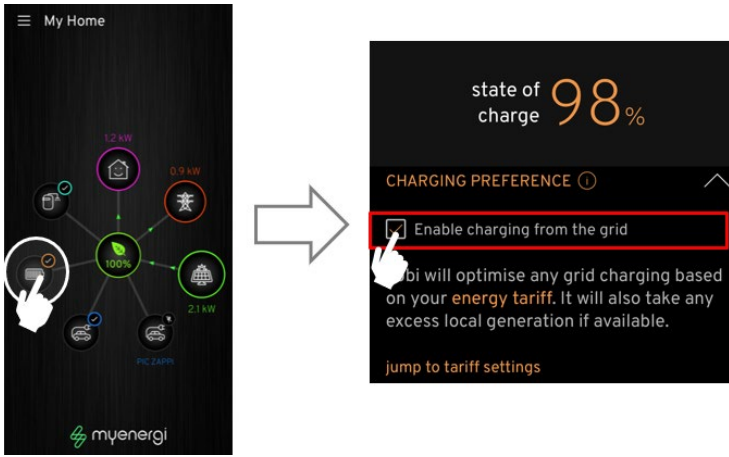

4.1.3 Grid only charging

For customers with no solar or wind generation, you can still have a myenergi libbi. If no generation is present at the property, the box labelled “Enable charging from the grid” will need to be ticked, as the grid will be the only source of energy for your libbi.

You will need to input your electricity tariff details into the app before you can start to charge, so libbi knows when it is cheapest for you and will choose to take and store energy at these cheaper times of the day.

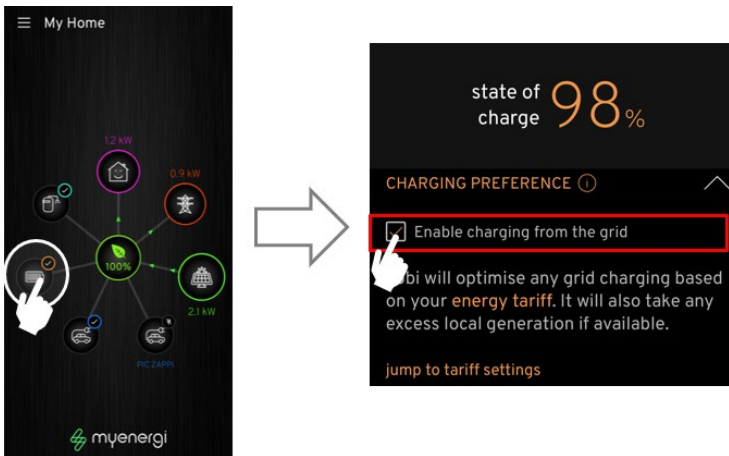

4.2 Input Electricity Tariff

If you have chosen to allow libbi to charge from the grid you must input your Electricity Tariff. This is so libbi knows when energy is cheapest for you and will only consume from the grid at those times.

You will be prompted to enter your tariff information in the app;

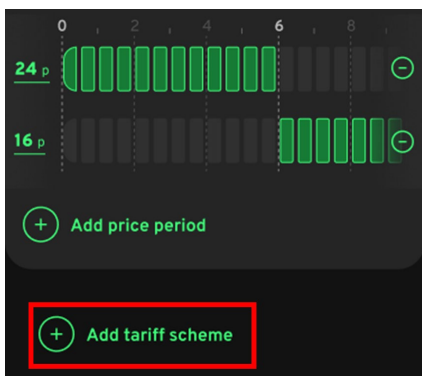

- **When the app detects a libbi** – If you are an existing myenergi customer with existing products and are already registered with the app, you will receive a pop-up message prompting you to set your tariff information as soon as libbi is detected i.e. when the app notices a libbi has been paired with your existing devices.

- **If you tick the box to enable charging from grid** – You have chosen to allow charging from the grid, you will receive a pop-up message prompting you to input your tariff details.

Step 1: Select your energy supplier and tariff. The drop down tariff selection options are, Single Rate, Dual Rate or Dynamic Rate.

Step 2: Once you have selected your energy supplier and tariff, click “Set my rates”

Step 3: Assign rates to times of the day on the next screen. If you have multiple rates throughout the day, you can add more by clicking “Add price period”.

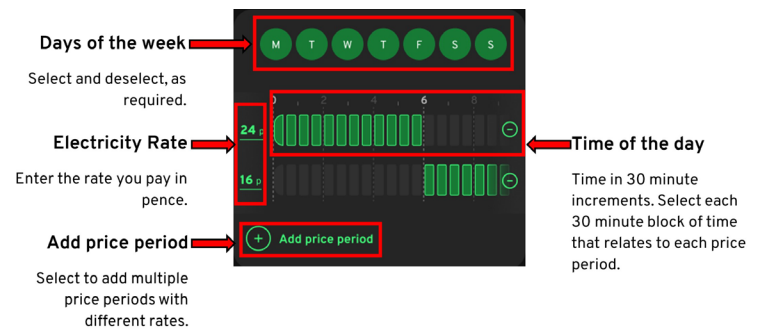
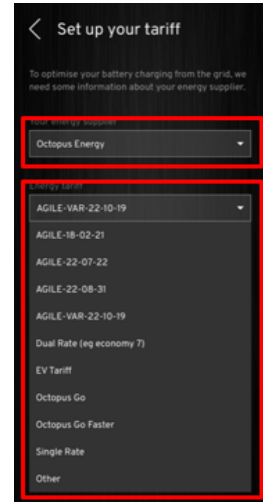

Step 4: If you have different prices for different days of the week, select “Add tariff scheme” to input the full detailed breakdown of day, time and rate.

Step 5: Once you have input your tariff details, select “Save” at the bottom of the screen.

You can amend and change your tariff details at any time by following the same instructions so, if you change supplier or tariff, just remember to hop on over to your app and update your energy tariff details.

If you selected a Single Rate Tariff at Step 2, it will not take you through to the next screen to enter your schedule of rates. As your rate is always the same, libbi does not need to know when it is ‘cheaper’ for you and will not charge from the grid.

4.3 Setting Priorities

If you have multiple myenergi devices you can control how energy is distributed to each of them in your app and it couldn't be simpler.

Using your finger, simply select the device you want to move and drag it to the priority position you want it to take.

The higher up towards the house icon, the higher the priority for surplus energy. The lower down and further away from the house icon the lesser the priority for surplus energy. If you have a myenergi eddi and/or zappi, regardless of the settings you have selected, libbi can only provide energy to the zappi and/or eddi if they are above them in priority. i.e. Anything below the house icon receives surplus energy in the order of priority, going downwards. Going upwards libbi will only provide energy to anything shown above it in priority.

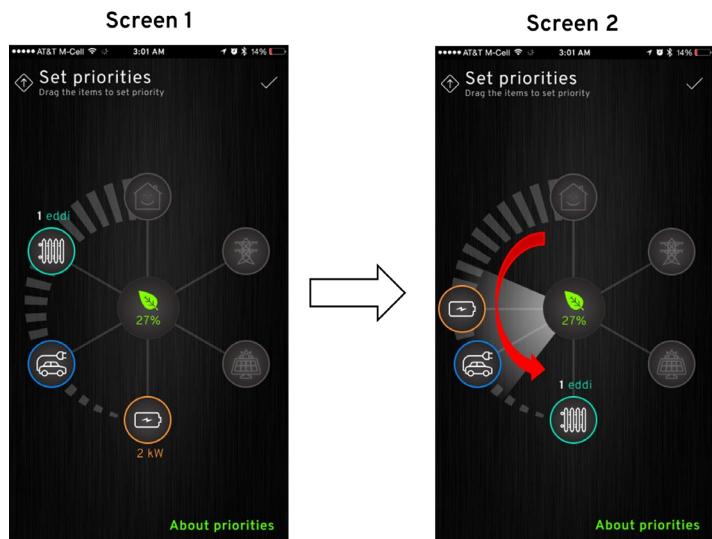

Screen 1, above, shows eddi as the highest priority and libbi as the lowest priority. So, eddi will receive any surplus energy first, followed by zappi and lastly followed by libbi. As libbi is below both zappi and eddi, libbi can supply energy to them both (depending on the settings you have selected for your zappi and eddi devices).

Screen 2, eddi has been dragged to the bottom which means eddi is now the lowest priority to receive surplus energy. libbi has been moved to the 'same' priority as zappi. Because they are the same priority, they will both receive surplus energy equally.

4.3.1 Priorities Explained

Example 1

For surplus generation energy, eddi is the highest priority, followed by the zappi, then followed by the libbi. This means eddi will receive any surplus energy first before it is offered to the zappi and lastly it will be given to the libbi, providing eddi and zappi aren't in requirement of it.



libbi is below both zappi and eddi meaning it can provide energy to both devices (depending on the preference you've selected either in your myenergi app or on the eddi/zappi device itself)

Example 2

For surplus generation energy, eddi and libbi are of equal highest priority so they will receive any surplus energy, equally, first. Surplus energy will lastly be offered to zappi which is lowest priority. libbi will not provide energy to devices on the same or lower priority than it.



Example 3

For surplus generation energy, libbi and eddi are of equal highest priority so they will receive any surplus energy equally first. Surplus energy will lastly be offered to zappi which is lowest priority. libbi will not provide energy to devices on the same or lower priority than it.



Example 4

For surplus generation energy, libbi is the highest priority, followed by the eddi, then followed by the zappi. This means libbi will receive any surplus energy first before it is offered to the eddi and lastly it will be offered to the zappi, providing eddi and libbi aren't in requirement of it. libbi is above both zappi and eddi meaning it cannot provide energy to either device. However, libbi can still provide energy to the home.



Example 5

This myenergi eco-system consists of two libbis and an eddi. We will refer to the highest libbi as libbi 1 and the lowest libbi as libbi 2, for this example.

For surplus generation energy, libbi 1 is the highest priority, followed by the eddi, then followed by libbi 2. This means libbi 1 will receive any surplus energy first before it is offered to the eddi and lastly it will be given to the libbi 2, providing eddi and libbi 1 aren't in requirement of it. libbi 1 is above eddi, meaning it cannot provide energy to it but it can still provide energy to the home. libbi 2 is positioned below eddi, meaning libbi 2 can provide energy to eddi as well as to the home.



5. libbi and zappi

For customers with a myenergi libbi and zappi, as well as being able to prioritise your devices, as spoken about in the previous section, you can also decide whether you want zappi to charge using your libbi or not.

5.1 Compatibility

libbi is not compatible with zappi V1 but is compatible with all later models.

When libbi is installed into an existing myenergi eco-system your installer must ensure all existing compatible devices are on the most current firmware in order for them to work with the libbi.

5.2 myenergi app (libbi and zappi)

In your myenergi app, there is the option to select whether or not you want zappi to consume from your libbi and it is a simple tick box.

Go to your app home screen and click the battery symbol. On the next page, scroll down to “Powered Devices”. If you would like libbi to provide energy to zappi then tick the box. If you would prefer libbi to never provide energy to zappi, leave this box unticked.



If you have more than one zappi, libbi will provide power equally to all devices, when plugged in at the same time, depending on your priority settings.

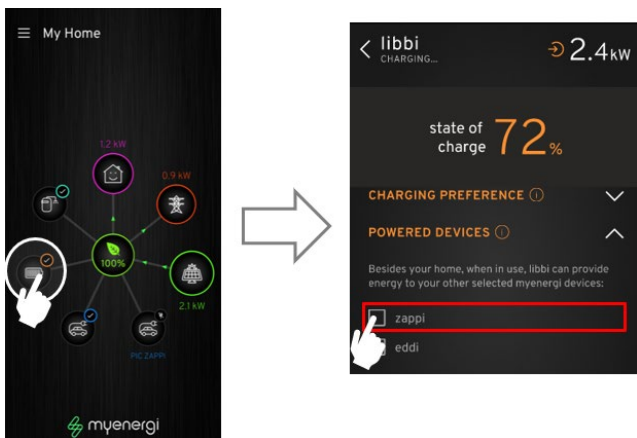

5.3 zappi Device Settings

A new menu item has been added to our zappi devices which allows you to select whether you want zappi to drain libbi to charge your car or not. Select “YES” if you would like it to use energy stored in libbi or select “NO” if you do not want zappi to use energy from libbi.

This option can be found by in your zappi device, navigating to: “Other Settings” > “Advanced” > “Supply Grid” > “Device”

5.4 zappi – FAST Mode

If using zappi in FAST mode, zappi will not use energy from libbi. zappi will always charge from the grid or available generation when in FAST Mode.



Refer to section 4.3 to understand how your priority settings may override the decisions you’ve selected in the above section.

6. libbi and eddi

For customers with a myenergi libbi and eddi, as well as being able to prioritise your devices, as spoken about in the previous section, you can also decide whether you want eddi to use energy from your libbi or not.

6.1 Compatibility

libbi is compatible with all eddi models.

When libbi is installed into an existing myenergi eco-system, your installer must ensure all existing compatible devices are on the most current firmware in order for them to work with the libbi.

6.2 myenergi app (libbi and eddi)

In your myenergi app, there is the option to select whether or not you want eddi to consume from your libbi and it is a simple tick box.

Go to your app home screen and click the battery symbol. On the next page, scroll down to “Powered Devices”. If you would like libbi to provide energy to eddi then tick the box. If you would prefer libbi to never provide energy to eddi, leave this box unticked.



If you have more than one eddi, libbi will provide power equally to all devices, when plugged in at the same time, depending on your priority settings.

6.3 eddi Device Settings

A new menu item has been added to our eddi devices which allows you to select whether you want libbi to discharge to eddi or not. Select “YES” if you would like it to use energy stored in libbi or select “NO” if you do not want eddi to use energy from libbi.

This option can be found by in your eddi device, navigating to: “Device Settings” > “Advanced” > “Supply Grid” > “Device”

SUPPLY GRID	
...	
Export Margin:	0W
Export Threshold:	0W
Response Delay:	0S
Drain libbi:	NO

6.4 eddi and Boost / Timed Boost

Regardless of all selected settings, eddi will never use energy from libbi when in Boost or Timed Boost Mode.



Refer to section 4.3 to understand how your priority settings may override the decisions you’ve selected in the above section.

SUPPLY GRID	
PHASE:	1
Phase Return:	Neutral
Device Limit:	0
Neutral Limit:	off
Earthing:	TT/TN
Max Grid Power:	off
Drain libbi:	YES

7. System Appearance

7.1 Battery and Inverter

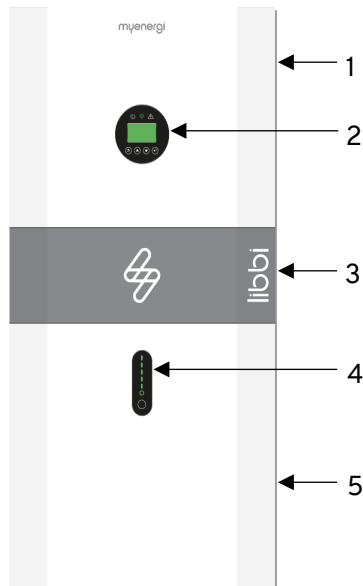

1.	Hybrid Inverter LIBBI-HS3680/HS5000
2.	On Board Display
3.	Cable Box (connected to inverter)
4.	Battery Capacity Indicator
5.	5.1kWh Battery Cell (Battery 1)

Inverter On Board Display and Light Indicators

You will be controlling your system using the libbi controller and the myenergi app so it isn't necessary to go into the inverter on board display menu.

However, we describe below what you can expect to see on your inverter's display and what those light indicators mean.



Icon	LED	What does it mean?
	Green	A solid green light Indicates libbi is on and there is a grid connection.
	Green (Flashing)	A flashing green light Indicates libbi is in standby.
	Green	A solid green light indicates there is an off-grid connection.
	Red	A solid red light indicates there is a system fault. See libbi controller display for fault code.

The display itself will continuously run through information screens whilst the unit is on. The screens you can expect to see are below:

TEMPERATURE		SYSTEM		ERROR NO.	
INV:	22.8°C	STATE:	PK SHIFT	WARNING:	W04-1
DCDC:	22.4°C	GRID:	U.K.	FAULT:	XXX-X
AMBIENT:	26.0°C	PV I/P:	INDEPEN		
BMS PARAM		BMS PARAM		BATTERY	
TYPE:	LFP	CHAR VOLT:	56.1V	VOLT:	51.63V
TEMP:	17.4°C	CHARGE:	50A	CURR:	-3.8A
SOC:	11.0%	DISCHARGE:	81A	CAPACITY:	100Ah
POWER		INV DATA		GRID DATA	
PV:	W	VOLT:	242.1V	VOLT:	241.7V
BACKUP:	W	CURR:	2.13A	CURR:	0.00A
BAT:	-560W	FREQ:	49.99Hz	FREQ:	49.98Hz
POWER		STATE		DC VOLTAGE	
INV:	-641W	SYS:	STANDBY	BUS:	383.8V
GRID:	W	INV:	STANDBY		
LOAD:	W	DCDC:	SOFT STAR		
BACKUP DATA		PV2 INPUT		PV1 INPUT	
VOLT:	243.5V	VOLT:	6.1V	VOLT:	5.4V
CURR:	0.00A	CURR:	0.00A	CURR:	0.00A
		POWER:	W	POWER:	W



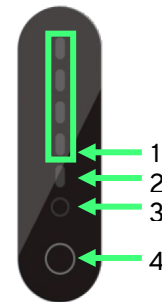

Battery Light Indicators

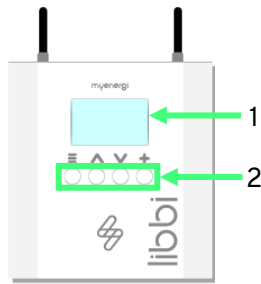

1.	Capacity Indicator – Each green light represents 25% of battery capacity. If solid green this indicates this section is full. If flashing green this indicates this section is currently charging. i.e. two solid green lights with a third flashing green light indicates 50% capacity is full and 51-75% is currently charging.
2.	Fault Indicator – Lights up red to indicate a fault with the system. See controller display for further information. Note: When switching the system on and off this light will show as red momentarily and then turn off.
3.	Running Light – A solid green light indicates the system is on. This will become a flashing green light when the battery is charging and discharging.
4.	Reset Button – For resetting the battery.

7.2 Controller



1. Display	Graphical LCD display with LED backlight
2. Control Buttons	Four tactile buttons to navigate the menus and alter settings:  Enter menu (from main screen) Exit current menu  Move up a menu item Increase value  Move down a menu item Decrease value  Select item Confirm value and move to next setting

7.3 Controller Status Screens

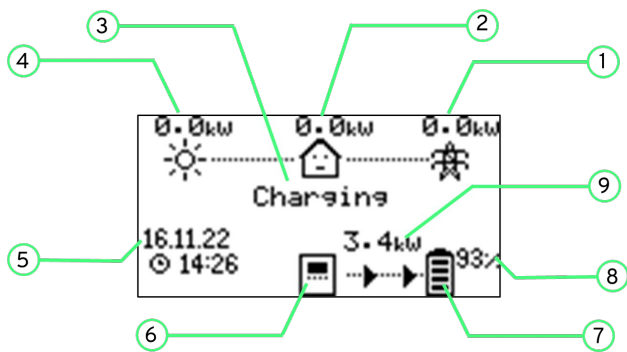

1.	Import/Export Power: The power imported/exported from the grid (kW). The arrow direction indicates if importing (left) or exporting (right).
2.	House Load Power: Power the property is currently using (kW). This option requires a generation CT or PV to be connected directly into libbi.
3.	Operating Mode: Current operating mode (status) of the libbi.
4.	Generation Power: Power being generated by solar or wind generation, if applicable. To measure this a CT must be connected to generation or PV directly connected into libbi.
5.	Date & Time: Current date and time.
6.	libbi Controller Icon
7.	libbi Battery Icon: Indicates the current charge state of the battery.
8.	Current Battery State of Charge (SoC): Indicates the percentage of charge within the battery.

7.4 Common Status Screens

This section gives you a brief overview of some of the common status screens you can expect to see on your libbi controller display and what they mean.

Starting Up

Seen briefly at start up when libbi first powers on.

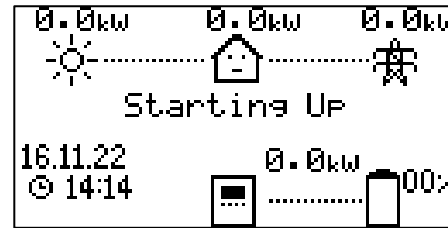

Charging

libbi battery is being charged.

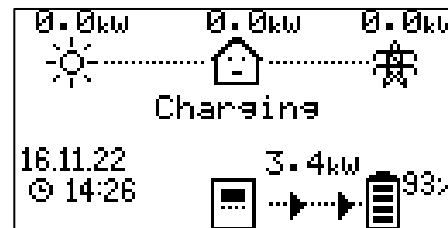

Idle

Appears when libbi is not charging or discharging.

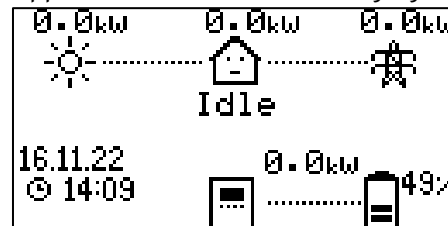

Libbi Lost

libbi controller has lost communication with the libbi inverter and battery.



Discharging

libbi battery is discharging.



Power On

Appears after the 'starting up' screen and shows libbi controller is powering on.

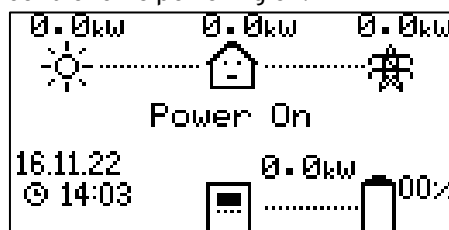

Battery Full

The battery is fully charged.

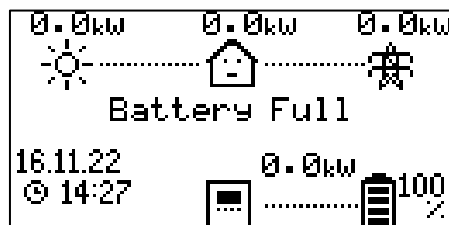

Battery Empty

libbi battery is fully drained.

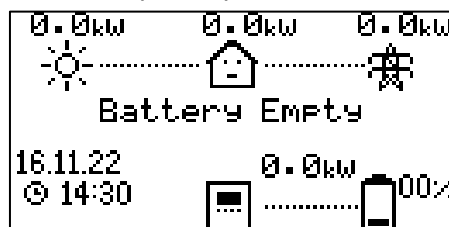

Master Lost

libbi is a slave device and has lost communication with the master device.

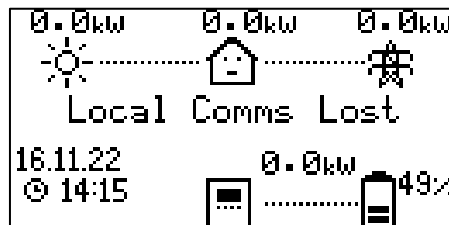

8. Firmware Updates

Updating the firmware on your devices is very important to ensure they continue to work as they should and they remain secure.

To check for available firmware updates, on your controller menu, navigate to;

Device Settings > Firmware Update

Firmware updates will automatically download in the background as and when available. Downloaded firmware can be installed by navigating to this screen and selecting "install". If any updates are available they will be listed here.

9. Operation After Power Failure

In the event of a power cut libbi will automatically reboot itself once connection the grid has been re-established.

If you have back-up connected your libbi will switch over to the back-up circuit using energy stored in libbi to power it.

Once grid connection has been re-established, libbi will automatically switch from back up mode back to grid mode.

10. Fault Codes

Code 58: Generation CT Polarity

Polarity of the gen CT is the wrong way around.

- 1) Contact installer.
- 2) If problem persists contact myenergi Tech Support.

Code 101: Battery Empty

Status only - The minimum state of charge has been met.

Code 102: Battery Full

Status only - The maximum state of charge has been met

Code 106: Grid CT Lost

Grid readings have been lost, device has stopped to be safe.

- 1) Contact installer.
- 2) If problem persists, contact myenergi Tech Support.

Code 107: Local Comms Lost

Load control device has been lost, device has stopped to be safe.

- 1) Ensure master device is powered on.
- 2) Check pairing of all devices and re-pair, if necessary.
- 3) Check all devices are on the same channel.
- 4) If issue cannot be resolved, call myenergi Tech Support.

Code 151: Inverter Undervoltage

The inverter reports low grid voltage.

- 1) Contact installer
- 2) If issue persists, contact myenergi Tech Support.

Code 152: Inverter Overvoltage

The inverter reports high grid voltage.

- 1) Contact myenergi Tech Support.

Code 153: Inverter Under Frequency

The inverter reports low grid frequency.

- 1) Contact myenergi Tech Support.

Code 154: Inverter Over Frequency

The inverter reports high grid frequency.

- 1) Contact myenergi Tech Support.

Code 156: Battery Lost

Communications between the battery and inverter have failed.

- 1) Check battery is turned on.
- 2) Contact installer.
- 3) Contact myenergi Tech Support.

Code 157: Battery Undervoltage

Battery voltage is under threshold.

- 1) Reboot Battery.
- 2) If issue persists, contact myenergi Tech Support.

Code 158: Battery Voltage Low

Reporting low battery voltage.

- 1) Reboot battery.
- 2) If issue persists, contact myenergi Tech Support.

Code 159: Battery Voltage High

Reporting high battery voltage.

- 1) Reboot battery.
- 2) If issue persists, contact myenergi Tech Support.

Code 160: Overload

Inverter circuit overloaded. Occurs when the demand is more than the inverter can deliver, when in backup mode.

- 1) Turn off loads powered by the backup circuit.
- 2) If problem persists, contact myenergi Tech Support

Code 161: GFCI Over Threshold

Inverter internal protection triggered due to internal fault in inverter.

- 1) Contact myenergi Tech Support.

Code 163: Fan Fault

Inverter fan fault detected.

- 1) Contact myenergi Tech Support.

Code 164: Bat Under Capacity

Battery power is insufficient to discharge.

- 1) Contact myenergi Tech Support.

Code 165: BMS Discharge Over Current

- 1) Reboot battery.
- 2) If issue persists, contact myenergi Tech Support.

Code 166: BMS Charge Over Current

- 1) Reboot battery.
- 2) If issue persists, contact myenergi Tech Support.

Code 167: BMS Over Voltage

- 1) Reboot battery.
- 2) If issue persists, contact myenergi Tech Support.

Code 168: BMS Over Temperature

- 1) Check ambient temperature at install site.
- 2) Contact myenergi Tech Support.

Code 169: BMS Discharge Temperature Low

- 1) Check ambient temperature at install site.
- 2) Contact myenergi Tech Support.

Code 170: Battery Voltage Imbalance

- 1) Reboot battery.
- 2) If issue persists, contact myenergi Tech Support.

Code 171: BMS Communications Fault

- 1) Reboot battery.
- 2) Contact installer.
- 3) If issue persists call Tech Support.

Code 172: BMS Under Voltage

- 1) Reboot battery.
- 2) Contact installer.
- 3) If issue persists, contact myenergi Tech Support.

Code 173: BMS Charge Temperature Low

- 1) Check ambient temperature at install site.
- 2) Contact Tech Support.

Code 174: BMS Voltage High

- 1) Reboot battery.
- 2) If issue persists, contact myenergi Tech Support.

Code 175: BMS Temperature High

- 1) Check ambient temperature at install site.
- 2) Contact myenergi Tech Support.

Code 179: Grid CT Polarity

Grid CT may be the wrong way around.

- 1) Contact installer.
- 2) If issue persists, contact myenergi Tech Support.

Code 183: Inv Comms Lost

- 1) Check inverter and controller are turned on.
- 2) Contact installer.
- 3) If problem persists contact myenergi Tech Support

Code 184: Controller Undervoltage

- 1) Contact DNO (Distributed Network Operator).
- 2) If issue persists, contact myenergi Tech Support.

Code 185: Controller Overvoltage

- 1) Contact DNO (Distributed Network Operator).
- 2) If issue persists, contact myenergi Tech Support.

Code 186: Controller Under Frequency

- 1) Contact DNO (Distributed Network Operator).
- 2) If issue persists, contact myenergi Tech Support.

Code 187: Controller Over Frequency

- 1) Contact DNO (Distributed Network Operator).
- 2) If issue persists, contact myenergi Tech Support.

Code 201: Soft Timeout

- 1) Power down following the power down procedure.
- 2) If issue persists, contact myenergi Tech Support.

Code 202: Internal Voltage Short

- 1) Power down following the power down procedure.
- 2) If issue persists, contact myenergi Tech Support.

Code 203: GFCI Sensor Fault

- 1) Power down following the power down procedure.
- 2) If issue persists, contact myenergi Tech Support.

Code 205: Bus Low Fault

- 1) Power down following the power down procedure.
- 2) If issue persists, contact myenergi Tech Support.

Code 206: Bus High Fault

- 1) Power down following the power down procedure.
- 2) If issue persists, contact myenergi Tech Support.

Code 207: Bus Short Fault

- 1) Power down following the power down procedure.
- 2) If issue persists, contact myenergi Tech Support.

Code 208: PV ISO Under

- 1) Power down following the power down procedure.
- 2) Contact installer.
- 3) If issue persists, contact myenergi Tech Support.

Code 209: PV Input Short Circuit

- 1) Disconnect PV safely using the DC isolator.
- 2) Power down following the power down procedure.
- 3) Contact installer.
- 4) If issue persists, contact myenergi Tech Support.

Code 210: Bypass Relay Fault

- 1) Disconnect PV safely using the DC isolator.

- 2) Power down following the power down procedure.
- 3) Contact installer.
- 4) If issue persists, contact myenergi Tech Support.

Code 211: Inverter Overcurrent

- 1) Wait 5 minutes for inverter to restart.
- 2) If issue persists, power down following the power down procedure.
- 3) Contact installer.
- 4) If problem still persists contact myenergi Tech Support.

Code 212: Inverter DC Over

- 1) Power down following the power down procedure.
- 2) If issue persists, contact myenergi Tech Support

Code 213: Ambient Over Temperature

- 1) Check ambient temperature at install site.
- 2) Power down following the power down procedure.
- 3) Power up libbi following the power up procedure.
- 4) If problem persists, contact myenergi Tech Support.

Code 214: Sink Over Temperature

- 1) Check ambient temperature at install site.
- 2) Power down following the power down procedure.
- 3) Power up libbi following the power up procedure.
- 4) If problem persists, contact myenergi Tech Support.

Code 215: Grid Relay Fault

- 1) Disconnect PV safely using the DC isolator.
- 2) Power down following the power down procedure.
- 3) Power up libbi following the power up procedure.
- 4) Reconnect PV.
- 5) Contact installer.
- 6) If issue persists, contact myenergi Tech Support.

Code 216: Discharge Overcurrent

- 1) Wait 1 minute for inverter to restart.
- 2) Power down following the power down procedure.
- 3) Power up libbi following the power up procedure.
- 4) If problem persists, contact myenergi Tech Support.

Code 217: Charge Overcurrent

- 1) Contact installer.
- 2) If issue persists, contact myenergi Tech Support.

Code 219: Inverter Abnormal

- 1) Power down following the power down procedure.
- 2) Power up libbi following the power up procedure.
- 3) If issue persists, contact myenergi Tech Support.

Code 220: EPS Relay Fault

- 1) Disconnect PV safely using the DC isolator.
- 2) Power down following the power down procedure.
- 3) Power up libbi following the power up procedure.
- 4) Reconnect PV.
- 5) Contact installer.
- 6) If issue persists, contact myenergi Tech Support.

Code 232: SCI Fault

- 1) Power down following the power down procedure.
- 2) Power up libbi following the power up procedure.
- 3) If issue persists, contact myenergi Tech Support.

Code 233: SoC Recovery

Status only - Libbi is charging to keep its SoC above a safety threshold

Code 234: Calibration Charge

Status only - Libbi is performing its calibration charge on first install

Code 251: Upgrading DSP

Status only - DSP upgrade on inverter has started - Will clear when upgrade is complete.

Code 252: Upgrading ARM

Status only - ARM upgrade on inverter has started - Will clear when upgrade is complete.

11. Routine Maintenance & Cleaning

We *recommend* a routine observation of the libbi every 6 months. This should be carried out by a competent person and its main aim is to look for any signs of damage and abnormalities. This is a visual inspection only and should not entail removing the cable box cover or dismantling the libbi in any way.

A full maintenance inspection is *recommended* to be carried out by a **qualified person** every 6-12 months. This is to check cables and terminals. Please speak to your installer to arrange this.

11.1 Emergency Power Down Procedure

If you are ever advised by myenergi Tech Support or by the fault code instruction to power down the libbi, follow the below procedure to do this safely.

- 1) Remove the cable box cover and set aside.
- 2) Unscrew the two thumb screws to access the switch box and open the switch box cover.
- 3) Turn off the battery switch.
- 4) Turn off the isolation switch on side of the battery or all batteries if the system has more than one. The switch is located beneath the side panel, which must first be unscrewed and removed.
- 5) Press and hold the power button on the front of the battery module until all the lights go out. Repeat this step for each battery module.
- 6) Turn off the backup/load isolation switch/breaker (if backup is connected).
- 7) Turn off AC Isolator.
- 8) Turn off the PV isolator, if applicable.

11.2 Battery Reboot

- 1) Remove the cable box cover and set aside.
- 2) Unscrew the two thumb screws to access the switch box and open the switch box cover.
- 3) Turn off battery switch.
- 4) Turn off the isolation switch on side of the battery or all batteries if the system has more than one. The switch is located beneath the side panel, which must first be unscrewed and removed.
- 5) Press and hold the power button on the front of the battery module until all the lights go out. Repeat this step for each battery module.
- 6) Leave for 30 seconds.

- 7) Turn on the isolation switch on the side of battery, or all batteries if the system has more than one.
- 8) Turn on the battery switch in the wiring box.
- 9) If issues persist, contact myenergi Tech Support.

12. Warranty

Full details of the myenergi libbi product warranty are available on our website or by scanning the QR code below.



<https://www.myenergi.com/terms-and-conditions/myenergi-libbi-system-warranty/>

13. Installer Portal

As part of the install, you, as the approved installer, are required to input the serial numbers of the inverter, battery(ies) and controller into the myenergi Installer Portal. This allows us to know when the customer's Warranty period begins.

If at any point in the future, the customer decides to upgrade their system by adding an extra battery, this will allow us to know when the Warranty period begins for the part added at a later date.

14. Technical Support

If you experience any issues with libbi during or post installation, please contact our technical support team by scanning the QR Code below:



<https://myenergi.com/manual-support/>

Please contact us directly for the quickest solution.

15. Our Products

For more information about other myenergi products, please visit

<https://myenergi.com/zappi>

<https://myenergi.com/eddi>

<https://myenergi.com/harvi>